



# Faber

INDUSTRIA MACCHINE CAFFÈ ITALIA

## SLOT

PLAST/INOX

**Manuale d'uso**

**User manual**

**Manual d'utilisation**

**Manual de instrucciones**

**Gebrauchsanweisungen**

مدخت سرمل لیلد



# Una Faber è per sempre!

Gentile Cliente i consigli che seguono ti saranno utili per garantire un corretto funzionamento e un'accurata manutenzione della tua macchina da caffè Faber!

» È importante, dopo ogni erogazione, rimuovere la cialda dall'apposito alloggiamento: se non lo fai subito dopo aver erogato il caffè, rischi di rimuovere anche l'apposita guarnizione insieme alla cialda ormai asciutta. In questo caso lascia scorrere un pò d'acqua prima di rimuoverla.

» La tanica della tua macchina Faber deve essere adeguatamente piena d'acqua, se non lo fai rischi di danneggiare la pompa di erogazione. È importante che il tubo di carico sia immerso nell'acqua.

» Fai una decalcificazione periodica!

Ricorda che l'acqua contiene sali di calcio e di magnesio che, quando riscaldati, possono formare il calcare, dannoso per tutti gli elettrodomestici, e quindi va eliminato. Il procedimento per la rimozione del calcare andrebbe ripetuto a seconda dell'utilizzo della macchina e della durezza dell'acqua, ogni 3 mesi circa e consta solo di 3 semplici passaggi. Ti consigliamo il nostro Decalcificante Faber e di seguire quindi le istruzioni sull'etichetta.

» Se occorre regola il tuo pressacialda con un semplice gesto!

Qualora dovessi notare una fuoriuscita di acqua in prossimità della cialda in fase di erogazione, hai la possibilità di regolare il pressacialda in ottone, ruotandolo verso sinistra e riportarlo quindi nella sua posizione originale al fine di ottenere sempre il miglior risultato in tazza.



**ATTIVA LA GARANZIA CON IL CODE  
O COMPILANDO IL COUPON DELL'ULTIMA PAGINA**  
**Da inviare via email, sul nostro sito o per posta.**

Segui i nostri social  
per tanti utili consigli!



# BENVENUTO NEL MONDO FABER!

Il presente libretto ti sarà utile per consentire un corretto funzionamento e un'accurata manutenzione della tua macchina da caffè.

## Il manuale va letto attentamente.

Esso è parte integrante del prodotto e va consegnato insieme allo stesso in caso di cessione ad altro utente o proprietario.

## Garanzia

1) L'apparecchio è garantito dalla OFI Srl per un periodo di 24 mesi dalla data in cui il primo utente ne ha fatto acquisto. La prova della data di acquisto, è indicata sul documento, valido agli effetti fiscali, rilasciato dal rivenditore. L'utente che voglia usufruire della garanzia, deve esibire il suddetto documento al personale tecnico che ne verificherà la regolarità.

2) Il consumatore, il cui bene abbia un difetto di conformità, **deve rivolgersi al rivenditore**, unico soggetto responsabile (in forza del contratto di vendita) nei suoi confronti.

3) La garanzia copre gli interventi di sostituzione o riparazione dovuti a vizi costruttivi o a difetto di conformità rispetto alle caratteristiche di prodotto, come dichiarate nei documenti accompagnatori, presenti al momento dell'acquisto.

4) Dalla garanzia sono espressamente esclusi quei difetti che si verificano a seguito di uso errato, negligenza oppure incuria nell'uso o nella custodia sono causati da errata installazione, manutenzione o riparazione da parte di persone non autorizzate o da danneggiamento durante il trasporto, - **non sono riconducibili a vizi di fabbricazione, ma piuttosto alla normale usura dei materiali dovuta all'uso proprio dell'apparecchio (in particolare, calcificazione e consumo delle parti soggette all'usura, come per esempio guarnizioni, filtro, pompa dell'acqua), sono stati provocati da fulmini, umidità, incendio, errata tensione in alimentazione così come tutti gli altri eventuali danni che non sono oggettivamente**

**te imputabili al produttore:** in particolare non sono coperti dalla Garanzia gli interventi sui difetti dovuti ad un uso non idoneo, alla mancata osservanza delle istruzioni per il funzionamento dell'apparecchio, a riparazioni effettuate con ricambi non originali, a opera di personale tecnico non autorizzato OFI Srl ovvero a circostanze che comunque, non possono farsi risalire a difetti di fabbricazione dell'apparecchio. **È inoltre esclusa la formazione di ruggine delle parti in metallo/ferro (si consiglia in tal senso di tenere la macchina sempre ben asciutta) e le macchie su acciaio dovute all'utilizzo di detergenti aggressivi.** Impregiudicati i diritti che l'Utente vanta nei confronti dei Venditori, suo diretto contraente, ai sensi della Direttiva 1944/44/CE e del suo decreto di recepimento. sono altresì esclusi dalla presente Garanzia gli interventi riguardanti l'installazione, l'allacciamento agli impianti di alimentazione e scarico la predisposizione dell'apparecchio alle condizioni di utilizzo, nonchè le manutenzioni riportate nel libretto di istruzioni; non sono infine coperte da Garanzia tutte quelle parti sottoposte ad usura cori il normale utilizzo (quali, a titolo esemplificativo, parti asportabili, guarnizioni, plastiche, ecc.).

5) La OFI Srl declina ogni responsabilità per eventuali danni che possono, direttamente o indirettamente, derivare da persone, cose o animali domestici a causa dell'inosservanza di tutte le prescrizioni indicate nell'apposito Libretto Istruzioni e riguardanti, principalmente, le avvertenze di installazione, uso e manutenzione, dell'apparecchio.

6) Le riparazioni effettuate in Garanzia non danno luogo a prolungamenti o rinnovo della Garanzia stessa.

## DICHIARAZIONE DI CONFORMITÀ

Apparecchiatura conforme alle direttive 2014/30/LIE (direttiva compatibilità elettromagnetica) e 2014151LIE (direttiva bassa e 20141351UL (direttiva bassa tensione)

# PRENDITI CURA DELLA TUA FABER!

Segui le nostre indicazioni o  
**recati presso un Centro di Assistenza**

## La tua Faber non si accende?

› Controlla che la presa di corrente sia funzionante.

## La spia del termostato che regola la temperatura (spia erogazione caffè/spia erogazione vapore) resta accesa/ non si accende?

› Recati presso un Centro di Assistenza

## La tua Faber non eroga più caffè?

- › Controlla che sia presente acqua nella tanica.
- › Controlla che il tubo di silicone sia posizionato correttamente nella tanica/serbatoio.
- › Pulisci il filtro doccia. 
- › Prova ad effettuare una decalcificazione dei circuiti.

## La tua Faber presenta un rumore anormale durante l'erogazione?

- › Controlla che sia presente acqua nella tanica/serbatoio.
- › Controlla che il tubicino in silicone posteriore sia correttamente inserito nell'apposita vaschetta.

## La tua Faber non pesca più acqua dall'apposito serbatoio?

- › Controlla che sia presente acqua nella tanica/serbatoio.
- › Controlla che il tubicino in silicone posteriore sia correttamente posizionato nell'apposita vaschetta.
- › Controlla che il tubicino in silicone sia intatto.

## La tua Faber presenta perdita di acqua dal pressacalda?

- › Controlla che durante l'erogazione la cialda sia posizionata correttamente nel suo alloggiamento.
- › Controlla che il pressacalda aderisca perfettamente alla cialda inserita fino allo scatto di chiusura.
- › Controlla sia presente l'oring in viton nella parte inferiore del pressacalda. 

## La tua Faber presenta perdita di acqua dalla parte superiore del pressacalda?

› Con le erogazioni il diffusore posto nella parte alta del pressacalda può allentarsi o usurare le sue guarnizioni: recati presso un Centro di Assistenza.

## La tua Faber presenta perdita di acqua sul ripiano di appoggio?

› Verifica che la vaschetta raccogli acqua sia integra e riposta correttamente.

## La tua Faber presenta un'erogazione troppo veloce?

- › Utilizza sempre cialde di buona qualità e dalla grammatura adatta (ESE 44 mm): una cialda con macinato di scarsa qualità/quantità pregiudica il risultato in tazza per un buon caffè!
- › Verifica che i termostati che regolano la temperatura si accendano e si spengano come di consueto (consulta le istruzioni d'uso sul presente manuale).
- › Regola il pressacalda in ottone. 

## La tua Faber presenta un'erogazione troppo lenta/a piccole gocce?

- › Controlla che sia presente acqua nel serbatoio.
- › Pulisci il filtro doccia. 
- › Prova ad effettuare una decalcificazione e una pulizia dei circuiti con prodotti mai troppo aggressivi, acidi o inadatti.

## La tua Faber eroga caffè freddo?

› Verifica che i termostati funzionino come di consueto. (consulta le istruzioni d'uso sul presente manuale)

Ti ricordiamo che sono esclusi dalla garanzia tutti i difetti causati da una cattiva manutenzione e/o utilizzo della tua Faber, pertanto ricorda di effettuare sempre una pulizia e una decalcificazione periodica della tua Faber, **acquista sul nostro decalcificante e detergente faberitaliasrl.it**

## Consulta i nostri consigli utili a pagina 2.

› Vedi tutorial sui ns canali social/sito 

## NORME GENERALI DI SICUREZZA

**Prima di installare la tua macchina, presta un attimo di attenzione:**

i simboli seguenti permetteranno di riconoscere le situazioni di pericolo, quelle in cui prendere delle precauzioni per non arrecare danno alla macchina, ti forniranno indicazioni necessarie per gestirla al meglio.









PERICOLO









ATTENZIONE/PRECAUZIONE



CONSIGLI UTILI

-  Non usare all'aperto.
-  Non usare con mani bagnate o piedi nudi.
-  Non esporre all'azione di agenti atmosferici anche se non collegato alla rete elettrica.
-  Non introdurre le mani, oggetti metallici ed altro, anche se non collegato alla rete elettrica.
-  Non consentire l'utilizzo dell'apparecchio da parte dei bambini inferiori agli 8 anni e da persone con ridotte capacità fisiche, sensoriali o mentali, o prive d'esperienza o della necessaria conoscenza se non sotto sorveglianza o se le stesse abbiano ricevuto istruzioni relative all'uso dell'apparecchio e della comprensione dei pericoli ad esse inerenti. I bambini non devono giocare con l'apparecchio. La pulizia e la manutenzione destinata ad essere effettuata dall'utilizzatore non deve essere effettuata da bambini senza sorveglianza.
-  Assolutamente non aprire la leva di chiusura del vano di alloggiamento cialda in fase di erogazione.
-  Prima di qualsiasi intervento di manutenzione rivolgersi al personale specializzato del nostro Centro Assistenza. Per sapere dove sono vai su [www.faberitaliasrl.it](http://www.faberitaliasrl.it)

-  Verificare periodicamente l'integrità del cavo di alimentazione che dovrà essere sostituito solo dal personale autorizzato.
-  Se il cavo di alimentazione è danneggiato, esso deve essere sostituito dal costruttore o dal suo servizio assistenza tecnica o comunque da una persona qualificata, in modo da prevenire ogni rischio.
-  Le operazioni di manutenzione e pulizia devono essere effettuate sempre quando la macchina è fredda e non collegata alla rete elettrica.
-  Per la pulizia della macchina utilizzare un semplice panno umido, facendo attenzione a non immergere mai la macchina in acqua e non inserire i componenti in lavastoviglie.
-  Non utilizzare solventi o prodotti chimici aggressivi.
-  Aver cura di non asciugare mai la macchina o i suoi componenti in forno (di qualsivoglia specie).

**Se trovi residui di acqua all'interno dei circuiti è perché le nostre macchine vengono testate una ad una dopo l'assemblaggio.**

# SLOT PLAST | INOX

## CARATTERISTICHE TECNICHE

- Telaio in metallo verniciato
- Coperture in ABS
- Frontale ABS/Inox
- Pompa 15 bar
- Scambiatore in alluminio
- Siluro e pressacalda regolabile in ottone
- Resistenza: 500 w
- Termoregolatore fisso 95°/145° RM
- Capacità serbatoio PET 1,3 Lt.
- Alimentazione 220 v - 50 Hz
- Alimentazione 110 v - Kit U.S.

## DIMENSIONI

Larghezza 21 cm | Profondità 32 cm  
Altezza 31 cm | Peso 5 Kg circa

## PRIMA INSTALLAZIONE

Rimuovere l'imballo ed assicurarsi che l'apparecchio sia integro, in caso contrario rivolgersi al proprio rivenditore senza utilizzarlo.

Tutti gli elementi dell'imballo rappresentano delle FONTI DI PERICOLO per bambini e portatori di handicap.

L'impianto elettrico deve essere dotato di messa a terra, la OFI Srl non può essere ritenuta responsabile per danni causati alla mancanza di messa a terra dell'impianto elettrico. Verificare che i dati tecnici dell'apparecchio siano compatibili con quelli della rete di distribuzione elettrica e con quelli del vostro impianto. Non utilizzare prolunghe o adattatori non omologati.



**(1)** Interruttore accensione ON/OFF **(2)** Spia luminosa temperatura **(3)** Interruttore erogazione caffè **(4)** Leva chiusura vano alloggio cialda **(5)** Filtro alloggio cialda **(6)** Vaschetta raccogli acqua **(7)** Coperchio vano serbatoio 1,3 lt **(8)** Beccuccio di erogazione

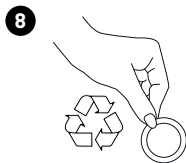
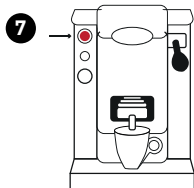
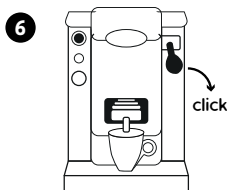
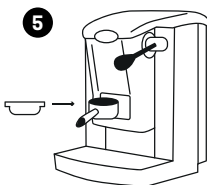
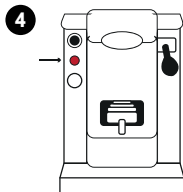
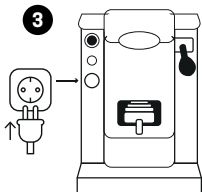
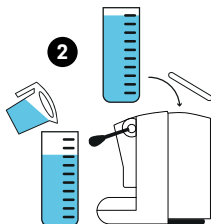
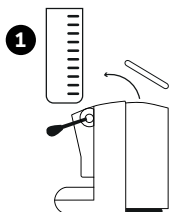

## ISTRUZIONI D'USO

**1.** Sollevare il coperchio dal vano serbatoio (7) ed estrarre lo stesso

**2.** Riempire d'acqua non frizzante posizionare il serbatoio all'interno del proprio alloggiamento facendo attenzione ad inserire il tubicino all'interno fino a circa 1 cm dal fondo

**3.** Inserire la spina in una presa di corrente e posizionare interruttore (1) in ON-Luce accesa

**4.** Attendere che la spia di temperatura (2) sia spenta

**5.** Posizionare la cialda sul proprio alloggiamento (5)

**6.** Azionare la leva (4) spingendo verso il basso fino allo scatto di chiusura

**7.** Premere il tasto di erogazione (3) fino al livello di caffè desiderato.

**8.** Rimuovere la cialda

# OPTIONAL VAPOR LANCIA VAPORE

## CARATTERISTICHE TECNICHE

- Telaio in metallo verniciato
- Vaschetta e griglia in ABS
- Pompa 15 bar
- Scambiatore in alluminio
- Siluro e pressacalda regolabile in ottone
- Lanciavapore cromata
- Termostato 250° riarmo manuale
- Termostato 200°
- Scambiatore schiacciato
- Resistenza: 500 w
- Termoregolatore fisso 95°/145° RM
- Capacità serbatoio PET 1,3 Lt.
- Alimentazione 220 v - 50 Hz
- Alimentazione 110 v - Kit U.S.

## DIMENSIONI

Larghezza 21 cm | Profondità 31 cm  
Altezza 32 cm | Peso 5 Kg circa

## PRIMA INSTALLAZIONE

Rimuovere l'imballo ed assicurarsi che l'apparecchio sia integro, in caso contrario rivolgersi al proprio rivenditore senza utilizzarlo.

Tutti gli elementi dell'imballo rappresentano delle FONTI DI PERICOLO per bambini e portatori di handicap.

L'impianto elettrico deve essere dotato di messa a terra, la OFI Srl non può essere ritenuta responsabile per danni causati alla mancanza di messa a terra dell'impianto elettrico. Verificare che i dati tecnici dell'apparecchio siano compatibili con quelli della rete di distribuzione elettrica e con quelli del vostro impianto. Non utilizzare prolunghe o adattatori non omologati.



- (1)** Interruttore accensione ON/OFF **(2)** Spia luminosa temperatura **(3)** Interruttore erogazione caffè **(4)** Leva chiusura vano alloggio cialda **(5)** Filtro alloggio cialda **(6)** Vaschetta raccogli acqua **(7)** Coperchio vano serbatoio 1,3 Lt **(8)** Beccuccio di erogazione **(8)** Beccuccio di erogazione **(E)** Manopola **(D)** Lanciavapore



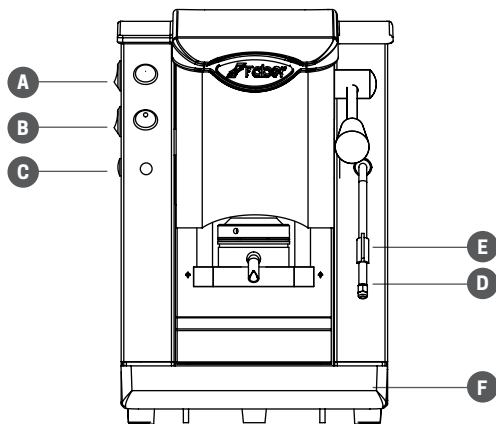

Fig 1

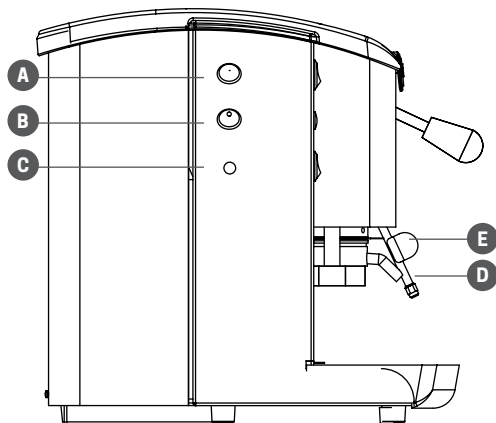

Fig 2

## LANCIA VAPORE

### ISTRUZIONI D'USO LANCIA VAPORE

1. Accendere la macchina (tasto A) attendere che la spia luminosa (spia luminosa C - Fig 2) sia spenta, questo segnala che la temperatura per l'erogazione del vapore è stata raggiunta.
2. Inserire il contenitore con il liquido da riscaldare e premere il tasto di erogazione del vapore (tasto B - Fig 2) fino al raggiungimento della temperatura desiderata, quindi premere nuovamente il tasto per arrestare l'erogazione del vapore.
3. Ripulire la lancia vapore dopo l'utilizzo mediante un panno umido.

### NOTA

Prima di eseguire le operazioni relative all'erogazione del vapore, assicurarsi che la lancia vapore sia orientata in direzione della vaschetta raccolta acqua.

Attenzione pericolo di scottature, manovrare la lancia vapore mediante l'apposita manopola.

Non orientare la lancia su persone e/o animali.

- A. Tasto accensione
- B. Tasto erogazione
- C. Spia luminosa
- D. Lancia vapore
- E. Manopola
- F. Vaschetta raccolta acqua

### Fig 1

Vista frontale tasti erogazione caffè

### Fig 2

Vista laterale tasti erogazione vapore

# SLOT PLAST | INOX ZODIAC

## CARATTERISTICHE TECNICHE

- Telaio in metallo verniciato
- Vaschetta e griglia in ABS
- Pompa 15 bar
- Scambiatore in alluminio
- Siluro e pressacalda regolabile in ottone
- **Dosatore a timer (caffè lungo/corto)**
- **Elettrovalvola**
- Resistenza: 500 w
- Termoregolatore fisso 95°/145° RM
- Capacità serbatoio PET 1,3 Lt.
- Alimentazione 220 v - 50 Hz
- Alimentazione 110 v - Kit U.S.

## DIMENSIONI

Larghezza 21 cm | Profondità 31 cm  
Altezza 32 cm | Peso 5 Kg circa

## PRIMA INSTALLAZIONE

Rimuovere l'imballo ed assicurarsi che l'apparecchio sia integro, in caso contrario rivolgersi al proprio rivenditore senza utilizzarlo.

Tutti gli elementi dell'imballo rappresentano delle FONTI DI PERICOLO per bambini e portatori di handicap.

L'impianto elettrico deve essere dotato di messa a terra, la OFI Srl non può essere ritenuta responsabile per danni causati alla mancanza di messa a terra dell'impianto elettrico. Verificare che i dati tecnici dell'apparecchio siano compatibili con quelli della rete di distribuzione elettrica e con quelli del vostro impianto. Non utilizzare prolunghe o adattatori non omologati.



**(T1 o T3)** Interruttore accensione ON/OFF **(1)**  
Leva chiusura vano alloggiamento cialda **(2)** Filtro  
alloggio cialda **(3)** Vaschetta raccogli acqua **(4)**  
Coperchio vano serbatoio 1,3 Lt **(5)** Beccuccio di  
erogazione

## ACCENSIONE APPARECCHIO

**Accensione:** premere il tasto T1 o T3 oppure contemporaneamente T1 e T3.

**Spegnimento:** Premere contemporaneamente T1 e T3 per 2 secondi.

## RISCALDAMENTO ACQUA

Alla prima accensione è necessario attendere che l'acqua venga riscaldata prima di poter procedere con l'erogazione del caffè.

Tutte le funzioni di erogazione risultano disabilitate e la fase di riscaldamento è segnalata all'utente con il lampeggio lento del led ICO1 e ICO 3 (1 secondo)

Non appena raggiunta la corretta temperatura dell'acqua si abilitano tutte le funzioni e la macchina risulta pronta all'erogazione.

La fase di macchina pronta è segnalata all'utente con l'accensione fissa del led ICO1 e ICO 3

## RISCALDAMENTO INIZIALE

All'accensione della macchina, quando raggiunta la temperatura di lavoro, viene automaticamente accesa la pompa per 0,8 secondi per preriscaldare l'acqua presente tra lo scambiatore e l'infusore. La funzione non viene svolta se lo scambiatore si scalda in meno di 5 secondi (era già caldo)

**Attiva di default**

## FUNZIONE CAFFÈ (2 dosi a tempo programmabili dall'utente)

**Tasto caffè corto o lungo (T1 – T3):** pressione momentanea per start -stop erogazione.

Stop erogazione automatica quando raggiunto il tempo prefissato oppure premendo il tasto caffè durante l'erogazione.

L'erogazione in corso è segnalata con il lampeggio del solo led (ICO1 o ICO3) corrispondente alla erogazione in corso.

L'utente può riprogrammare a piacere la durata od il volume di erogazione del caffè corto o lungo con la seguente modalità operativa (esempio riprogrammazione caffè corto):

- 1.** Iniziare l'erogazione premendo e mantenendo premuto il tasto T1.
- 2.** Terminare l'erogazione rilasciando il tasto quando raggiunta la q.tà desiderata.
- 3.** La nuova durata di erogazione viene automaticamente salvata e verrà riproposta ad ogni successiva erogazione.

## VALORI DURATA EROGAZIONE CAFFÈ

	Default di fabbrica	Programmabile dall'utente
T1 - Erogazione caffè corto	24 secondi	Minimo 10 sec./Massimo 75 sec.
T3 - Erogazione caffè lungo	33 secondi	Minimo 10 sec./Massimo 75 sec.

La nuova durata viene memorizzata solo se superiore a 10 secondi

## CONFIGURAZIONE SISTEMA

### Configurazione preriscaldamentoacqua (attivazione Spina+ T3 - config. T1 T3 IC01 IC03)

1. Inserire la spina nella presa della corrente tenendo premuto tasto T3
2. Dopo circa 1 sec. IC01 e IC03 lampeggiano alternativamente velocemente ad indicare l'attivazione della configurazione
3. Rilasciare T3
4. Lampeggio IC01 funzione disattivata
5. Lampeggio IC02 funzione attivata
6. Premere T3 per definire l'ON/OFF della funzione, premere T1 per salvare l'impostazione
7. Attendere per 5 secondi senza premere tasti per uscire dalla configurazione.
8. Uscita configurazione in "Riscaldamento"

### Configurazione Reset parametri di fabbrica (attivazione Spina+ T1+T3 - config. T1 T3 IC01 IC03)

1. Inserire la spina nella presa della corrente tenendo premuto i tasti T1 e T3
2. Dopo circa 1 sec. T1 e T3 lampeggia velocemente T1 e poi T3
3. Rilasciare T1 e T3

### Reset ai parametri di fabbrica (Attivazione Spina + T1 +T3)

# I nostri accessori

Gli esclusivi accessori per macchine da caffè in cialde Faber e la nostra selezione di cialde rendono ancora più comoda e piacevole la tua pausa.

Tutto a portata di mano su **faberitaliasrl.it**



## Filtro addolcitore

Contiene una resina particolare in grado di depurare l'acqua dalle impurità e dal calcare in modo da migliorare la qualità del caffè!



## Portaccessori

In plastica, utile a raccogliere cialde, bustine di zucchero e palettine. Applicabile ad incastro sulla parte superiore delle SLOT PLAST e INOX.



## Decalcificante

E per prenderti cura della tua Faber, un decalcificante studiato ad hoc, senza sostanze acide e/o aggressive per una cura perfetta della macchina da caffè.



## Portabicchieri

In acciaio, dotato di una calamita. Può essere sistemato lateralmente alla macchina attratto dal materiale metallico.

## GARANZIA DEL PRODUTTORE

**1)** L'apparecchio è garantito dalla OFI srl per un periodo di 24 mesi dalla data in cui il primo utente ne ha fatto acquisto.

La prova della data di acquisto, è indicata dal documento valido ai effetti fiscali rilasciato dal rivenditore, in cui vi siano presenti i dati del rivenditore. L'utente che voglia usufruire della garanzia convenzionale offerta da OFI srl, deve esibire il suddetto documento al personale tecnico che ne verificherà la regolarità.

**2)** La garanzia copre gli interventi di sostituzione o riparazione dovuti a vizi costruttivi o a difetto di conformità rispetto alle caratteristiche di prodotto, come dichiarate nei documenti accompagnatori, presenti al momento dell'acquisto.

**3)** Non sono coperti dalla Garanzia gli interventi sui difetti dovuti ad un uso non idoneo, negligente o trascurato, ad uso improprio, in particolare non domestico, a mancata osservanza delle istruzioni per il funzionamento dell'apparecchio, a riparazioni effettuate con ricambi non originali, a opera di personale tecnico non autorizzato OFI srl, ovvero

Ritagliare lungo la linea tratteggiata

VEDI RETRO -->



**Faber** 

### PRODOTTO DA

**OFI srl**

Viale Melvin Jones 8, 81100 Caserta  
info@lofficinadifaber.com  
www.faberitaliasrl.it

Compila i campi con il modello e la matricola del prodotto acquistato:

**MATRICOLA**

**TIMBRO RIVENDITORE**

### ATTENZIONE!

**RITAGLIA E RISPEDI SCI IN BUSTA CHIUSA ALL'INDIRIZZO QUI SOPRA RIPIORTATO, ALLEGANDO LA RELATIVA FATTURA O RICEVUTA FISCALE DELL'ACQUISTO. PUOI COMPILARE IL MODULO DI GARANZIA ANCHE DAL NOSTRO SITO WWW.FABERITALIASRL.IT NELLA SEZONE SERVIZIO CLIENTI**

## GARANZIA DEL PRODUTTORE

a circostanze che, comunque, non possono farsi risalire a difetti di fabbricazione dell'apparecchio. Impregiudicati i diritti che l'Utente vanta nei confronti dei Venditori, suo diretto contraente, ai sensi della Direttiva 1944/44/CE e del suo decreto di recepimento, sono altresì esclusi dalla presente Garanzia gli interventi riguardante l'installazione, l'allacciamento agli impianti di alimentazione e scarico, la predisposizione dell'apparecchio alle condizioni di utilizzo, nonchè le manutenzioni riportate nel libretto di istruzioni; non sono infine coperte da Garanzia tutte quelle parti sottoposte ad usura con il normale

utilizzo (quali, a titolo esemplificativo, parti asportabili, guarnizioni, plastiche, ecc.).

**4)** La OFI srl declina ogni responsabilità per eventuali danni che possono, direttamente o indirettamente, derivare da persone, cose o animali domestici a causa dell'inosservanza di tutte le prescrizioni indicate nell'apposito Libretto Istruzioni e riguardanti, principalmente, le avvertenze di installazione, uso e manutenzione, dell'apparecchio.

**5)** Le riparazioni effettuate in Garanzia non danno luogo a prolungamenti o rinnovo della Garanzia stessa.

Ritagliare lungo la linea tratteggiata



## CLIENTE PRIVILEGIATO / TAGLIANDO DI ATTIVAZIONE DELLA GARANZIA

IMPORTANTE: compilare in maiuscolo e rispettare per registrare il vostro prodotto

Sig./Sig.ra				Nome				Cognome			
Via						Località					
Prov.		Cap		Telefono				Data di acquisto (gg/mm/aa)			
								/   /			
Nome e indirizzo del rivenditore											

L'interessato/a/i presa visione dell'informativa sul trattamento dei dati personali da parte del titolare, di cui all'informativa allegata al prodotto, ai cataloghi ed al materiale informativo in genere, ivi compresi il sito internet, ne conferma la lettura ed il suo consenso Informato/a/i per iscritto circa le finalità e le modalità del trattamento dei dati, il carattere facoltativo o obbligatorio del loro conferimento, le conseguenze dell'eventuale rifiuto a rispondere, i soggetti a cui i dati possono essere comunicati e l'ambito di decisione, do il consenso al trattamento dei dati per la finalità di cui ai punti e),1)

# A Faber is forever!

Dear Customer, the following tips will be useful for you to ensure that your Faber coffee machine functions properly and is correctly maintained!

» After each dispensing, it is important to remove the pod from the special housing: if you do not do it immediately after dispensing the coffee, you risk also removing the special seal along with the now dry pod. In this case, let some water flow before removing it.

» Your Faber coffee machine's tank must be adequately filled with water: if it is not, you risk damaging the delivery pump. It is important that the inlet tube is immersed in water.

» Perform a periodic descaling!

Remember that water contains calcium and magnesium salts which, when heated, can form limescale, which are harmful to all appliances and must therefore be removed. The process for removing limescale should be repeated according to the use of the machine and the hardness of the water, approximately every 3 months. It consists of just 3 simple steps. We recommend you use our Faber Descaler and then follow the instructions on the label.

» If necessary, adjust your pod press with a simple gesture!

Should you notice water leaking near the pod when dispensing, you can adjust the brass pod press, turning it to the left and then returning it to its original position. This way you always get the best cup of coffee.



**ACTIVATE THE WARRANTY WITH THE CODE**

**This is sent by email, through our website or by post.**

Follow our social networks  
for many useful tips!





# WELCOME TO THE WORLD OF FABER!

This booklet will be useful for you to ensure you properly operate and correctly maintain your coffee machine.

## **The manual must be read carefully.**

It is an integral part of the product and it is delivered together with it in case it is transferred to another user or owner.

## **Warranty**

1) The device is guaranteed by OFI S.r.l. for a period of 12 months from the date when the first user purchased it. The proof of the purchase date is indicated on the document, which is valid for tax purposes and has been issued by the retailer. The user who wants to take advantage of the warranty must show the aforementioned document to the technical personnel who will verify its correctness.

**The guarantee is only valid for Italy.**  
**For information about any service centres abroad, contact customer support.**

2) The consumer whose goods lack conformity **must contact the retailer**, who is the only person responsible towards them (under the sales contract).

3) The warranty covers replacement or repairs due to manufacturing defects or lack of conformity in the product characteristics, as declared in the accompanying documents, present at the time of purchase.

4) The warranty expressly excludes those defects that occur as a result of incorrect use, negligence or carelessness in use or storage and are caused by incorrect installation, maintenance or repair by unauthorised persons or damage during transport - **they are not attributable to manufacturing defects, but rather to normal wear and tear of the materials due to the proper use of the appliance (in particular, calcification and use of parts which wear out, such as gaskets, filter, water pump), or have been caused by lightning, humidity, fire, in-**

**correct power supply voltage as well as all other damage that is not objectively attributable to the manufacturer:** in particular, interventions on defects due to unsuitable use, failure to observe the instructions for operating the appliance, repairs carried out with non-original spare parts, or by unauthorised OFI S.r.l. technical personnel or circumstances which, in any case, cannot be traced back to manufacturing defects in the appliance are not covered by the Warranty. **Rust forming on the metal/iron parts is also excluded (it is advisable to always keep the machine dry) and stains on steel due to the use of aggressive detergents.**

Without prejudice to the rights that the User has towards the Retailers, their direct contractor, pursuant to Directive 1944/44/EC and its transposed decree for interventions concerning the installation, connection to feeding and drainage systems, the preparation of the appliance for the conditions of use, as well as the maintenance indicated in the instruction manual are also excluded from this Warranty. All those parts that are subject to wear and tear during normal use (such as, by way of example, removable parts, gaskets, plastics, etc.) are not covered by the Warranty.

5) OFI S.r.l. declines all responsibility for any damage that may, directly or indirectly, derive from people, things or pets due to non-compliance with all the prescriptions indicated in the specific Instruction Booklet and mainly concerning warnings about the installation, use and maintenance of the appliance.

6) Repairs carried out under Warranty do not extend or renew said Warranty.

## **DECLARATION OF CONFORMITY**

Equipment compliant with directives 2014/30/EMC (electromagnetic compatibility directive) and 2014/51/EU (low directive and 2014/35/UL (low voltage directive)

# TAKE CARE OF YOUR FABER!

Follow our directions or  
**go to a Service Centre**

## **Your Faber won't turn on?**

- > Check that the power socket is working.

## **Does the light for the thermostat that regulates the temperature (coffee dispensing light/steam dispensing light) stay on/not turn on?**

- > Go to a Service Centre

## **Your Faber no longer dispenses coffee?**

- > Check that there is water in the tank.
- > Check that the silicone tube is properly positioned in the tank.
- > Clean the shower filter. 
- > Try to descale the circuits.

## **Your Faber makes an unusual noise when dispensing?**

- > Check that there is water in the tank.
- > Check that the rear silicone tube is correctly inserted in the appropriate tray.

## **Your Faber no longer draws water from the appropriate tank?**

- > Check that there is water in the tank.
- > Check that the rear silicone tube is correctly positioned in the appropriate tray.
- > Check that the silicone tube is undamaged.

## **Your Faber is leaking from the pod press?**

- > Check that the pod is correctly positioned in its housing when dispensing.
- > Check that the pod press adheres correctly to the inserted pod until it clicks shut.
- > Check that the Viton O-ring is present in the bottom part of the pod press. 

## **Your Faber is leaking from the top of the pod press?**

- > The diffuser placed in the upper part of the pod press can loosen or wear out its gaskets from dispensing: go to a Service Centre.

## **Your Faber is leaking water onto the shelf?**

- > Check that the drip tray is undamaged and stored correctly.

## **Your Faber is dispensing too quickly?**

- > Always use good quality pods with a suitable weight (ESE 44 mm): a pod with poor quality/quantity ground coffee jeopardises the chance for a good cup of coffee!
- > Check that the thermostats that regulate the temperature switch on and off as usual (consult the instructions for use in this manual).
- > Adjust the brass pod press. 

## **Your Faber is dispensing too slowly/only dispensing small drops?**

- > Check that there is water in the tank.
- > Clean the shower filter. 
- > Try to descale and clean the circuits with products that are not too aggressive, acidic or unsuitable.

## **Your Faber makes cold coffee?**

- > Check that the thermostats work as per usual (see the instructions for use in this manual)

We remind you that all defects caused by poor maintenance and/or use of your Faber are excluded from the warranty. Remember to always periodically clean and descale your Faber. Buy our descaling and detergent products at: **faberitaliasrl.it**

## **Check out our useful tips on page 2.**

- > See tutorials on our social channels/website 

# GENERAL SAFETY INSTRUCTIONS

**Before installing your machine, take a moment to familiarise yourself with the following:**

the following symbols will allow you to recognise dangerous situations, situations where you should take precautions so as not to damage the machine and provide you with the necessary information to manage it in the best possible way.















DANGER



WARNING/CAUTION



USEFUL TIPS

-  Do not use outdoors.
-  Do not use with wet hands or bare feet.
-  Do not expose the machine to atmospheric agents, even if it is not connected to the mains.
-  Do not put your hands, metal objects and anything else into the machine, even if it is not connected to the mains.
-  Do not allow the appliance to be used by children under the age of 8 and by people with reduced physical, sensory or mental abilities, or without prior experience or the necessary knowledge, unless they are under supervision or if they have received instructions relating to using the appliance and an understanding of the inherent dangers. Children must not play with the appliance. Cleaning and maintenance to be performed by the user must not be carried out by children without appropriate supervision.
-  Absolutely do not open the closing lever of the pod housing compartment during dispensing.
-  Before any maintenance, contact our Support Centre's specialised personnel. To find out where they are go to [www.faberitaliasrl.it](http://www.faberitaliasrl.it)
-  Periodically check the integrity of the power cable which must only be replaced by authorised personnel.
-  If the power cable is damaged, it must be replaced by the manufacturer or by a servicing company or a similarly qualified person in order to avoid hazards.
-  Maintenance and cleaning operations must always be carried out when the machine is cooled down and disconnected from the mains.
-  To clean the machine use a simple damp cloth, taking care to never immerse the machine in water or put the components in the dishwasher.
-  Do not use solvents or aggressive chemical products.
-  Take care to never dry the machine or its components in the oven (of any kind).

**If you find water residue inside the circuits, it is because our machines are tested one by one after assembly.**

# SLOT

## PLAST | INOX

### TECHNICAL SPECIFICATIONS

- Coated metal frame
- ABS covers
- ABS/inox front
- 15 bar pump
- Aluminium exchanger
- Pod and adjustable brass pod press
- Resistance: 500 w
- Fixed temperature regulator 95°/145° RM
- Tank capacity PET 1.3 L
- Power supply 220v – 50 Hz
- Power supply 110 v – U.S. kit

### DIMENSIONS

Width 21 cm | Depth 31 cm

Height 32 cm | Weight approx. 5 kg

### FIRST-TIME INSTALLATION

Remove the packaging and make sure that the appliance is intact. If not, contact your retailer without using it.

All the packaging elements represent SOURCES OF DANGER for children and the handicapped. The electrical system must be grounded. OFI S.r.l. cannot be held responsible for damage caused by not grounding the electrical system. Check that the technical data for the appliance is compatible with that of the electrical distribution network and your system. Do not use unapproved extension cables or adapters.



- (1)** ON/OFF switch **(2)** Temperature indicator light **(3)** Coffee dispensing switch **(4)** Pod compartment closing lever **(5)** Pod compartment filter **(6)** Drip tray **(7)** 1.3 L tank compartment lid **(8)** Delivery spout

## INSTRUCTIONS FOR USE

1. Lift the lid from the tank compartment (7) and remove it
2. Fill with still water then place the tank inside its housing, making sure to insert the tube inside up to about 1 cm from the bottom
3. Insert the plug into a power socket and position the (1) ON-Light switch to on
4. Wait for the temperature light (2) to go out
5. Place the pod in its housing (5)
6. Operate the lever (4) pushing down until it clicks shut
7. Press the dispensing button (3) until the desired coffee level is reached.
8. Remove the pod

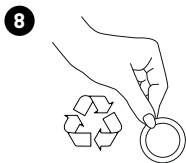
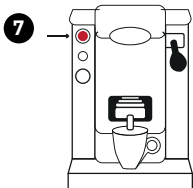
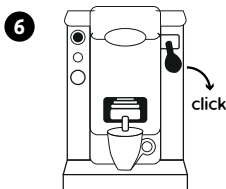
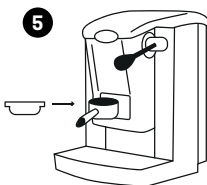
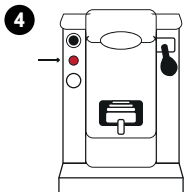
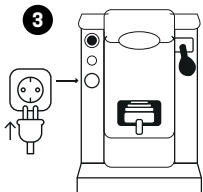
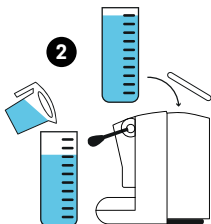
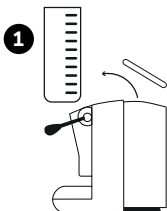

# OPTIONAL STEAM STEAM WAND

## TECHNICAL SPECIFICATIONS

- Coated steel frame
- ABS tray and grill
- 15 bar pump
- Aluminium exchanger
- Pod and adjustable brass pod press
- 250° thermostat manual reset
- 200° thermostat
- Grounds exchanger
- Resistance: 500 w
- Fixed temperature regulator 95°/145° RM
- Tank capacity PET 1.3 L
- Power supply 220v - 50 Hz
- Power supply 110 v - U.S. kit

## DIMENSIONS

Width 21 cm | Depth 31 cm

Height 32 cm | Weight approx. 5 kg

## FIRST-TIME INSTALLATION

Remove the packaging and make sure that the appliance is intact. If not, contact your retailer without using it.

All the packaging elements represent SOURCES OF DANGER for children and the handicapped. The electrical system must be grounded. OFI S.r.l. cannot be held responsible for damage caused by not grounding the electrical system. Check that the technical data for the appliance is compatible with that of the electrical distribution network and your system. Do not use unapproved extension cables or adapters.



- (1)** ON/OFF switch **(2)** Temperature indicator light **(3)** Coffee dispensing switch **(4)** Pod compartment closing lever **(5)** Pod compartment filter **(6)** Drip tray **(7)** 1.3 L tank compartment lid **(8)** Delivery spout **(E)** Knob **(D)** Steam wand

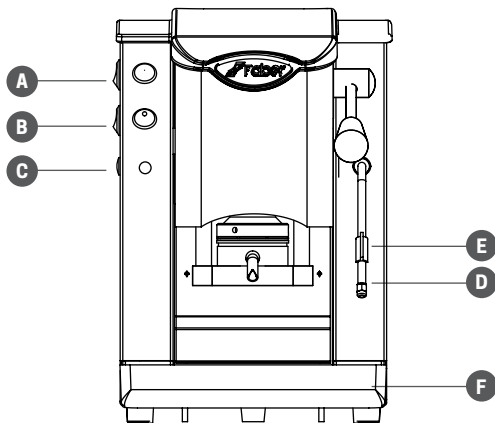

Fig 1

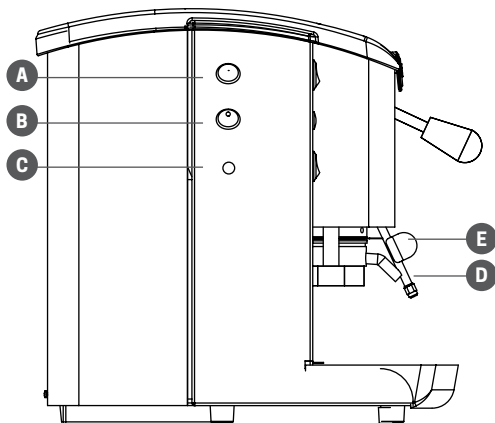

Fig 2

## STEAM WAND

### STEAM WAND INSTRUCTIONS FOR USE

1. Turn on the machine (button A) and wait for the indicator light (indicator light C - Fig. 2) to go out. This indicates that the temperature for steam delivery has been reached.
2. Insert the container with the liquid that is to be heated and press the steam dispensing button (button B - Fig. 2) until the desired temperature is reached, then press the button again to stop steam dispensing.
3. Clean the steam wand after use with a damp cloth.

### NOTES

Before carrying out the operations for steam delivery, make sure that the steam wand is aimed towards the water collection tank.

Warning: danger of burns. Operate the steam wand using the appropriate knob.

Do not aim the wand at people and/or animals.

- A. Power button
- B. Delivery button
- C. Indicator light
- D. Steam wand
- E. Knob
- F. Drip tray

### Fig 1

Front view of coffee dispensing buttons

### Fig 2

Side view of steam dispensing buttons

# SLOT PLAST | INOX ZODIAC

## TECHNICAL SPECIFICATIONS

- Coated frame
- ABS tray and grill
- 15 bar pump
- Aluminium exchanger
- Pod and adjustable brass pod press
- **Timed dispenser (long/short coffee)**
- **Solenoid valve**
- Resistance: 500 w
- Fixed temperature regulator 95°/145° RM
- Tank capacity PET 1.3 L
- Power supply 220v - 50 Hz
- Power supply 110 v - U.S. kit

## DIMENSIONS

Width 21 cm | Depth 31 cm

Height 32 cm | Weight approx. 5 kg

## FIRST-TIME INSTALLATION

Remove the packaging and make sure that the appliance is intact. If not, contact your retailer without using it.

All the packaging elements represent SOURCES OF DANGER for children and the handicapped. The electrical system must be grounded. OFI S.r.l. cannot be held responsible for damage caused by not grounding the electrical system. Check that the technical data for the appliance is compatible with that of the electrical distribution network and your system. Do not use unapproved extension cables or adapters.



**(T1 o T3)** ON/OFF switch **(1)** Pod compartment closing lever **(2)** Pod compartment filter **(3)** Drip tray **(4)** 1.3 L tank compartment lid **(5)** Delivery spout



## POWERING ON THE APPLIANCE

**Switching on appliance:** Press the T1 or T3 button or T1 and T3 simultaneously to turn on the device. Press T1 and T3 simultaneously for 2 seconds to turn off the device.

## WATER HEATING

The first time it is switched on, it is necessary to wait for the water to be heated before being able to proceed with coffee brewing.

All the dispensing functions are disabled and the heating phase is signaled to the user with slow flashing of the ICO1 and ICO 3 LEDs (1 second)

As soon as the correct water temperature is reached, all functions are enabled and the machine is ready for delivery.

The machine ready phase is signaled to the user with fixed lighting of the ICO1 and ICO 3 LEDs

## INITIAL HEATING

When the machine is turned on, when the working temperature is reached, the pump is automatically turned on for 0.8 seconds to preheat the water present between the exchanger and the infuser. The function is not carried out if the exchanger heats up in less than 5 seconds (it was already hot)

**Activate by default**

## COFFEE FUNCTION (2 timed doses programmable by the user)

Short or long coffee button (T1 - T3): momentary pressure to start-stop dispensing.

Stop automatic brewing when the preset time is reached or by pressing the coffee button during brewing.

The brewing in progress is signaled by the flashing of only the LED (ICO1 or ICO3) corresponding to brewing in progress.

## VALUES DURATION COFFEE BREWING

	Factory Default	Programmable by user
T1 - Brewing short coffee	24 seconds	Minimum 10 sec./Maximum 75 sec.
T3 - Brewing long coffee	33 seconds	Minimum 10 sec./Maximum 75 sec.

The new duration is saved only if superior to 10 seconds.

## CONFIGURATION SYSTEM

### Configuration water preheating (Plug + T3 activation - T1 T3 IC01 IC03 config.)

1. Insert the plug into the socket while pressing the key T3
2. After about 1 sec. IC01 and IC03 alternately flash quickly to indicate the activation of the configuration
3. Release T3
4. IC01 flashing function disabled
5. IC02 flashing function activated
6. Press T3 to define the ON / OFF of the function, press T1 to save the setting
7. Wait for 5 seconds without pressing any buttons to exit the configuration.
8. Configuration output in "Heating"

### Configuration Reset factory parameters

#### (activation of Plug + T1 + T3 - config. T1 T3 IC01 IC03)

1. Insert the plug into the socket while holding down the buttons T1 and T3.
2. After about 1 sec. IC01 and IC03 quickly flashes IC01 and then IC03
3. Release T1 and T3

### Reset to factory parameters (Plug Activation + T1 + T3)



# Our accessories

The exclusive optional for coffee pod machine Faber and our coffee pod selection make your coffee break more than comfortable.

Everything at your fingertips on [www.faberitaliasrl.it](http://www.faberitaliasrl.it)

.....



## Water softner cleaner

It contains a special resin that clean the water from impurity and limestone so you have the best quality of your coffee.



## Faber Accessory holder

In plastic useful for storing pods, sugar sachets and scoops. Can be interlocked onto the top of the SLOT PLAST and INOX.



## Descaler

You can take care about your Faber machine with a descaler specially made without acid and aggressive material for a perfect care of your coffee machine.



## Faber cup holder

Steel, equipped with a magnet. It can be placed to the side of the machine with the metallic magnetic attraction.

## Compliments pour avoir acheté votre machine à café **FABER!**

Ce manuel vous sera utile pour le fonctionnement correct et l'entretien soigné de votre machine à café.

### **Lire attentivement ce manuel.**

Il est partie intégrante du produit et doit être livré avec le produit en cas de cession à un autre utilisateur ou propriétaire.

## **GARANTIE**

Attention: La garantie n'est valable que sur le territoire national et selon la réglementation en vigueur. Pour toute information, envoyez un email à [customer@lofficinadifaber.com](mailto:customer@lofficinadifaber.com)

Tous les défauts de fabrication évidents et cachés sont garantis pour 12 mois à compter de la date d'achat. Tous les détraquements causés par l'utilisation erronée, l'usure, les écarts électriques et les courts-circuits, et même par les obstructions dûes à l'accumulation de calcaire sont exclus par la garantie.

Le fabricant donne garantie au client.

La société Ofi Srl ne sera pas considérée responsable pour les dommages commerciaux ou d'image, ni pour les dommages à choses ou personnes causés par une utilisation impropre du produit.

## **CE DECLARATION DE CONFORMITE**

Produit conforme aux directives 2014/30/UE (directive concernant la compatibilité électromagnétique) et 2014/35/UE (directive concernant certaines limites de tension)

## **REGLES GENERALES DE SECURITE**

Avant de l'installation de la machine, nous vous prions de prêter attention: les symboles suivants vous permettront de reconnaître les situations de danger, les situations dans lesquelles il est nécessaire prendre des mesures afin de ne causer pas de dommages à la machine, et vous donneront les indications nécessaires afin d'exploiter au mieux votre machine.











ATTENTION/  
MESURE



ANGER



CONSEILS  
UTILES

-  N'utiliser pas en plein air
-  N'utiliser pas avec mains mouillées ou nus-pieds
-  N'exposer pas aux actions des agents atmosphériques même si la machine n'est pas connectée au réseau électrique
-  N'introduire pas mains, objets métalliques et divers, même si la machine n'est pas connectée au réseau électrique
-  L'utilisation de la machine est interdite aux enfants âgés moins de 8 ans et aux sujets avec des capacités physiques, sensorielles ou mentales réduites ou sans l'expérience ou la connaissance nécessaires sauf sous surveillance ou si les sujets susmentionnés ont reçu les instructions concernant l'utilisation de la machine et les dangers joints. Les enfants ne doivent pas jouer avec la machine.
-  Le nettoyage et l'entretien par l'utilisateur ne doivent être effectués par les enfants sans surveillance.
-  N'ouvrir pas le levier de fermeture (4) de la boîte de logement de la gaufre pendant le refoulement. Vérifier périodiquement l'intégrité du câble d'alimentation, lequel doit être remplacé seulement par notre personnel autorisé.
-  En cas de dommages au câble d'alimentation, ce doit être remplacé par le constructeur ou par son service d'assistance technique ou en tous cas par un sujet qualifié, afin d'éviter tous dangers.



# SLOT

## VERSION PLAST ET INOX

Machine à café à dosette, compacte avec un design à la mode. Lignes sobres, proportions équilibrées, parfaite pour la maison et pour le bureau.

### CARACTÉRISTIQUES TECHNIQUES

- Cadre en métal peint
- Couvercles ABS
- Façade en ABS / Inox
- Échangeur en aluminium avec torpille en laiton
- Presse-gaufre en laiton
- Thermostat fixe 95°/98°
- Capacité du réservoir PET 1,3 Lt
- Alimentation 220v-50hz
- Pompe 15 bar

### DIMENSIONS

Largeur 21 cm | Profondeur 31 cm  
Hauteur 32 cm | Poids 5 Kg

### PREMIERE INSTALLATION

Enlever l'emballage et s'assurer que la machine est intacte, dans le cas contraire s'adresser au revendeur sans l'utiliser. Tous les éléments de l'emballage représentent des DANGERS pour les enfants et les personnes handicapées. L'installation électrique doit être équipée avec mise à la terre, la société OFI Srl ne peut pas être considérée responsable pour les dommages causés par l'absence de mise à la terre de l'installation électrique. Vérifier que les données techniques de la machine sont compatibles avec les données du réseau électrique et de votre installation. N'utiliser pas de rallonges ou adaptateurs non homologués.



**(1)** Interrupteur d'allumage ON/OFF **(2)** Témoin de température **(3)** Interrupteur de refoulement du café **(4)** levier de fermeture de la boîte de logement de la gaufre **(5)** Filtre de logement de la gaufre **(6)** Bac de recueillement de l'eau **(7)** Couvercle du réservoir max 1,3 lt **(8)** Bec de refoulement

## INSTRUCTIONS POUR L'UTILISATION

**1.** Soulever le couvercle du réservoir (7) et l'extraire.

**2.** Remplir avec eau non minérale positionner le réservoir dans son logement en prêtant attention à insérer le petit tube à l'intérieur jusqu'à environ 1cm du fond.

**3.** Insérer la fiche dans la prise de courant et positionner l'interrupteur (1) sur ON-Lumière allumée.

**4.** Attendre la coupure du témoin de température (2)

**5.** Positionner la gaufre sur son logement (5)

**6.** Eactionner le levier (4) en poussant vers le bas jusqu'à la détente de fermeture.

**7.** Positionner un petit verre/une petite tasse sous le bec de refoulement (8) et actionner l'interrupteur de refoulement du café (3)  
Quand on est arrivé au niveau de refoulement désiré, désactiver l'interrupteur de refoulement du café (3)

**8.** Ouvrir à nouveau, en actionnant vers le haut le levier de fermeture et extraire la gaufre utilisée

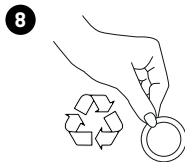
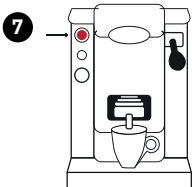
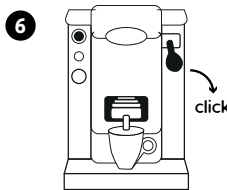
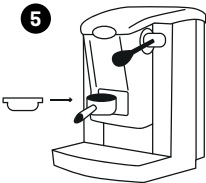
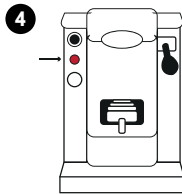
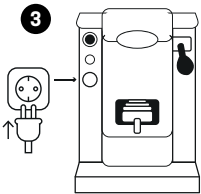
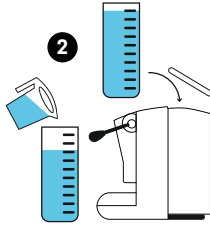
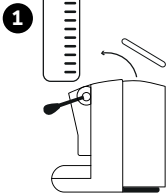

## INSTRUCTIONS POUR L'UTILISATION DE LA LANCE VAPEUR

1. Positionner l'interrupteur (A) sur ON-Lumière allumée
2. Attendre la coupure du témoin de température (B)
3. Positionner le briquette, insérer la lance vapeur et actionner l'interrupteur de refoulement (C)
4. Quand on est arrivé au niveau de refoulement de la vapeur désiré, désactiver l'interrupteur de refoulement (C).



**(A)** Interrupteur d'allumage groupe vapeur ON/OFF **(B)** Témoin de température **(C)** Interrupteur de refoulement de la vapeur **(D)** Lance vapeur **(E)** Petite poignée en plastique

## ✓ CONSEILS UTILES POUR L'ENTRETIEN



Les opérations d'entretien et de nettoyage doivent être effectuées toujours quand la machine est froide et n'est pas connectée au réseau électrique.



Pour le nettoyage de la machine utiliser un tissu humide, ne plonger jamais la machine dans l'eau et n'insérer pas ses éléments dans le lave-vaisselle.



N'utiliser pas de solvants ou de produits chimiques agressifs.



N'essayer jamais la machine ou ses éléments dans le four (de quelque typologie).

» Autres conseils utiles pour l'entretien sont disponibles sur le site: [www.fabertaliasrl.it](http://www.fabertaliasrl.it)

## Felicitaciones por la compra de su máquina de café **FABER!**

Este manual le será útil para asegurar un correcto funcionamiento y operación de su máquina de café.

### Lea atentamente este manual.

Este manual es parte del producto y tiene que ser entregado en caso de venta o cesión de la maquina a otra persona o propietario.

## GARANTÍA

Atención : La garantía solo es válida en el territorio nacional y de acuerdo con la normativa vigente. Para cualquier información, envíe un correo electrónico a [customer@officinadifaber.com](mailto:customer@officinadifaber.com)

Todos los defectos de fábrica visibles y ocultos tienen una garantía de 12 meses desde la fecha de compra. Se excluyen todas las fallas causadas por el mal uso, desgaste, sobretensión y cortocircuitos, así como las que resultan de la acumulación de obstrucciones de cal.

La garantía es concedida al cliente mediante el fabricante.

OFI Srl no se hace responsable de ningún daño comercial o de imagen, o por daños a personas o bienes causados por un uso indebido de la máquina.

## CE DECLARACIÓN DE CONFORMIDAD

Equipo de acuerdo con las directivas 2014/30 / UE (Directiva EMC) y 2014/35 / UE (directiva de baja tensión)

## NORMAS GENERALES DE SEGURIDAD

Antes de instalar su máquina, preste un momento de atención: Los siguientes símbolos permitirán reconocer situaciones peligrosas, aquellas en las que debe tomar precauciones para evitar cualquier daño a la máquina, proporcionando la información necesaria para tratar mejor su máquina.



ATENCIÓN/  
PRECAUCIÓN



PELIGRO



CONSEJOS  
ÚTILES

-  No la utilice en exteriores.
-  No la utilice con las manos mojadas o los pies descalzos.
-  No la esponja a los agentes atmosféricos, incluso si no está conectado a la red eléctrica.
-  No introduzca las manos, objetos de metal y cualquier otro elemento en la máquina, incluso si no está conectado a la red eléctrica.
-  El aparato puede ser utilizado por personas (incluidos niños) con capacidades físicas, sensoriales o mentales reducidas o sin experiencia, siempre bajo la supervisión o recibiendo instrucciones relativas al utilizo del aparato y a la comprensión de los peligros que conlleva. Los niños no deben jugar con la maquina. La limpieza y el mantenimiento que debe realizar el usuario no deben ser efectuados por niños sin supervisión. Antes de cualquier operación de mantenimiento al aparato desconecte el enchufe del tomacorriente.
-  No abra la palanca de cierre (4) del espacio que aloja el prensa-filtro bajo ninguna circunstancia durante la erogación.
-  Compruebe periódicamente la integridad del cable de alimentación, si fuera necesario, deberá ser reemplazado únicamente por personal autorizado.
-  Si el cable de alimentación está dañado, debe ser reemplazado por el fabricante, por parte de su servicio técnico o una persona calificada con el fin de prevenir todo tipo de peligro.



# SLOT

## VERSIÓN PLAST Y INOX

Cafetera de diseño compacto y elegante. Líneas sobrias, proporciones equilibradas, es perfecta tanto para el hogar y como para la oficina.

### CARACTERÍSTICAS TÉCNICAS

- Estructura de metal pintado
- Cubiertas de ABS
- Frente en ABS / Inox
- Intercambiador de calor de aluminio con porta-filtro de latón
- Latón prensa-filtro
- Controlador de temperatura fija de 95° / 98°
- Capacidad del depósito de PET de 1,3 litros
- Fuente de alimentación 220v-50hz
- Bomba 15 bar

### DIMENSIONES

Ancho 21 cm | Profundidad 31 cm

Alto 32 cm | Peso 5 Kg

### PREMIERE INSTALLATION

Retire el embalaje y asegúrese de que el equipo esté intacto, si no es así, por favor, póngase en contacto con su distribuidor antes de utilizarlo. Todos los elementos de embalaje representan una FUENTE DE PELIGRO para los niños y personas con capacidades físicas, sensoriales o mentales. La instalación eléctrica debe estar equipada con toma de tierra, OFI SRL no se hace responsable de los daños causados por la falta de toma de tierra de la instalación eléctrica. Asegúrese de que los datos técnicos del dispositivo sean compatibles con los de la red de distribución de eléctrica y con aquellos de vuestra instalación. No utilice cables de extensión o adaptadores no homologados.



- (1) El interruptor ON / OFF de alimentación  
(2) Piloto de la temperatura (3) Interruptor de suministro de café (4) Palanca de cierre del compartimiento porta-filtro (5) Portafiltros (6) Bandeja de recogida de agua (7) Cubierta del compartimiento del tanque máx. 1,3 lt (8) Boquilla de suministro

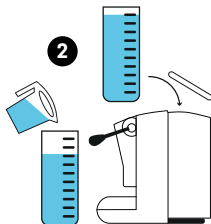
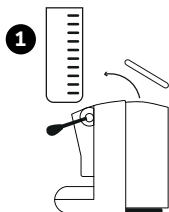

## INSTRUCCIONES DE USO

**1.** Levante la tapa del compartimiento del tanque (7) y saque el depósito.

**2.** Llene el depósito de agua natural (sin gas) coloque el depósito en su alojamiento asegurándose de insertar el tubo interior hasta al menos 1 cm de la parte inferior.

**3.** Conecte el enchufe en un toma corriente y presionar el interruptor (1) en la posición ON - luz encendida.

**4.** Esperar a que el piloto de temperatura (2) se apague.

**5.** Posicionar el filtro en su compartimiento (5)

**6.** Presionar la palanca (4) empujándolo hacia abajo hasta que haga el click de cierre total. Coloque un vaso / taza debajo de la boquilla de suministro (8) y pulse el interruptor de suministro de café (3)

**7.** Una vez conseguido el nivel deseado de erogación de café, apague el interruptor de suministro (3)

**8.** Vuelva a abrir, presionando hacia arriba la palanca de bloqueo y quite la dosis utilizada.

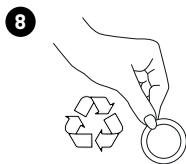
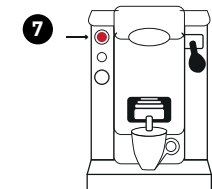
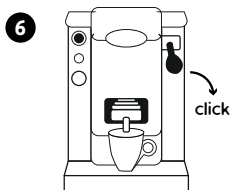
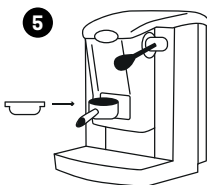
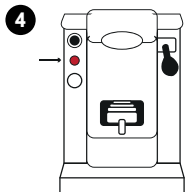
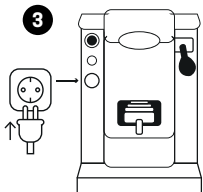

## INSTRUCCIONES DE USO DE LA LANZA DE VAPOR

**1.** Presionar del interruptor en la posición ON - luz encendida

**2.** Esperar a que el piloto de temperatura (B) está apagado

**3.** Coloque la jarra, inserte la boquilla de vapor y hacer funcionar el interruptor de erogación (C)

**4.** En el nivel deseado de erogación de vapor, apague el interruptor de suministro (C).

**5.** La lanza de vapor giratoria (D), es para ser utilizada sólo por el asa de seguridad de plástico (E). No toque la boquilla de vapor (D) directamente con las manos.

**(A)** Interruptor encendido apagado del módulo vapor ON / OFF **(B)** Piloto de temperatura **(C)** Interruptor erogación de vapor **(D)** Lanza de vapor giratoria **(E)** Tirador de plástico pequeño



### ✓ CONSEJOS ÚTILES DE MANTENIMIENTO



Las operaciones de mantenimiento y limpieza siempre deben llevarse a cabo cuando la máquina está fría y desconectada de la red eléctrica.



Para limpiar la máquina utilizar un paño húmedo, teniendo cuidado de no sumergir la máquina en agua y no poner las piezas en el lavavajillas.



No utilice disolventes o productos químicos agresivos.



Tenga cuidado de no secar la máquina o sus componentes en el horno (de cualquier tipo).

» Encontrará más consejos útiles de mantenimiento en el sitio web: [www.faberitaliasrl.it](http://www.faberitaliasrl.it)

## Herzlichen Glückwunsch für den Einkauf Ihrer Kaffeemaschine **FABER!**

Diese Gebrauchsanweisungen sind nützlich für ein korrektes Funktionieren und eine sorgfältige Instandhaltung Ihrer Kaffeemaschine.

### **Lesen Sie bitte diese Gebrauchsanweisungen aufmerksam durch.**

Sie sind integrierender Bestandteil des Produktes und sollen mit diesem geliefert werden, wenn es einem anderen Benutzer oder Eigentümer übertragen wird.

### **GARANTIE**

Anmerkung: Die Garantie gilt nur im Inland und gemäß den geltenden Vorschriften. Für weitere Informationen senden Sie eine E-Mail an [customer@officinadifaber.com](mailto:customer@officinadifaber.com)

Alle offensichtlichen und versteckten Herstellungsfehler sind für 12 Monate ab dem Einkaufsdatum garantiert. Alle Fehler, die von falscher Benutzung, Verschleiss, Stromwechsell und Kurzschlüssen, sowie von den Verstopfungen wegen Kalksteinhaufen verursacht werden, sind von der Garantie ausgeschlossen.

Der Hersteller leistet dem Kunden die Garantie. OFI SRL ist nicht verantwortlich für Handels- oder Bildbeschädigungen, sowie für Sach- oder Personenschaden wegen einer missbräuchlichen Verwendung der Maschine.

### **CE KONFORMITÄTSERKLÄRUNG**

Maschine gemäss den Richtlinien 2014/30/UE (Richtlinie über die elektromagnetische Verträglichkeit) und 2014/35/UE (Richtlinie über bestimmte Spannungsgrenzen)

## **ALLGEMEINE SICHERHEITSGESETZUNGEN**

Vor der Installation der Maschine sehen Sie bitte die folgenden Symbole aufmerksam an, die Ihnen ermöglichen, die Gefahrensituationen sowie die Situationen zu erkennen, in denen es notwendig ist, bestimmte Massnahmen zu treffen, um die Maschine nicht zu beschädigen. Die o.g. Symbole werden Sie Ihnen auch die notwendigen Hinweise angeben, um Ihre Maschine am besten zu verwenden.











Vorsicht/  
Massnahme



Gefahr



Nützliche  
Ratschläge

-  Bitte im Freien nicht benutzen
-  Bitte nicht benutzen mit nassen Händen oder mit blossen Füssen
-  Bitte nicht Witterungseinflüssen aussetzen, auch wenn die Maschine mit keinem Stromnetz verbunden ist
-  Bitte keine Hände, Metallobjekte oder sonstige Gegenstände einstecken, auch wenn die Maschine mit keinem Stromnetz verbunden ist
-  Die Verwendung der Maschine von Kindern unter 8 Jahre und von Personen mit reduzierten physischen, sinnlichen oder geistlichen Fähigkeiten sowie von Personen ohne die notwendigen Erfahrungen oder Kenntnissen ist verboten, ausser wenn unter Überwachung oder wenn diese Hinweise über die Verwendung der Maschine und die entsprechenden Gefahren bekommen haben. Kinder müssen mit der Maschine nicht spielen.
-  Die Reinigung und die Instandhaltung vom Benutzer muss nicht von Kindern ohne Überwachung durchgeführt werden.
-  Öffnen Sie bitte nicht den Verschlusshebel (4) des Kapselgehäuses während der Versorgung. Prüfen Sie bitte periodisch die Integrität des Stromversorgungskabels, das nur vom unseren befugten Personal ersetzt werden muss
-  Wenn das Versorgungskabel beschädigt ist, muss es vom Hersteller oder seinem technischen Betreuungsservice oder auf jeden Fall von einer qualifizierten Person ersetzt werden, um jede Gefahr zu vermeiden.



# SLOT

## PLAST UND INOX VERSION

Kaffeemaschine mit Kapseln, kompakt mit einem modische Design. Sachlicher Stil, ausgeglichene Proportionen, einwandfrei für beide Haus und Büro.

### Technische Eigenschaften

- Rahmen aus lackiertem Metall
- ABS-Abdeckungen
- Vorne in ABS / Inox
- Aluminiumaustauscher mit Messingrohr
- Messingkapselpresse
- Fester Temperaturregler 95°/98°
- Behälterstragfähigkeit PET 1,3 lt
- Versorgung 220v-50hz
- Pumpe 15 bar

### Dimensionen

Breite 21 cm | Tiefe 31 cm  
Höhe 32 cm | Gewicht 5 Kg

### ERSTE INSTALLATION

Beseitigen Sie bitte die Verpackung und sichern Sie sich bitte, dass die Maschine unversehrt ist, andernfalls wenden Sie sich bitte an Ihren Verkäufer an, ohne die Maschine zu verwenden. Alle Verpackungsteile vertreten eine GEFAHR für Kinder und Behinderte. Die elektrische Anlage muss mit Erdschluss versorgt werden, OFI Srl ist nicht verantwortlich für Schaden, die aus Erdschlussmangel der elektrischen Anlage verursacht werden. Prüfen Sie bitte, dass die technischen Daten der Maschine den Daten des Stromversorgungsnetzes sowie Ihrer Anlage entsprechen. Benutzen Sie bitte keine unzugelassenen Verlängerungskabel oder Adapter.



- (1)** Zündanlassschalter ON/OFF **(2)** Temperaturanzeigelampe **(3)** Schalter für Kaffeeverorgung **(4)** Verschlusshebel des Kapselgehäuses **(5)** Kapselgehäusefilter **(6)** Wasserschale **(7)** Behälterdeckel max 1,3 lt **(8)** Versorgungsstülle

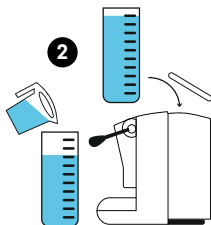
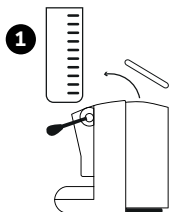

## GEBRAUCHSANWEISUNGEN

**1.** Den Behälterdeckel (7) aufheben und ihn herausziehen.

**2.** Mit stillem Wasser ausfüllen. Den Behälter in sein Gehäuse stellen. Vorsicht: stecken Sie bitte das kleine Rohr in den Inneren bis ca. 1cm aus dem Boden ein.

**3.** Den Stecker in eine Steckdose einstecken Den Schalter (1) auf ON-Licht ein-legen.

**4.** Warten, bis wann die Temperaturanzeigelampe (2) zu ist.

**5.** Die Kapsel auf ihr Gehäuse legen (5)

**6.** Den Hebel (4) beim Drücken nach unten bis zur Verschlussperklinke betätigen ein kleines Glas/eine kleine Tasse unter der Versorgungsstüle stellen (8) und den Schalter für Kaffeeversorgung (3) betätigen.

**7.** Wenn das gewünschte Versorgungs-niveau erreicht wird, den Schalter für Kaffeeversorgung (3) zu machen

**8.** Öffnen beim Betätigen des Verschlusshebels nach oben und die verwendete Kapsel beseitigen.

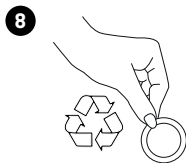
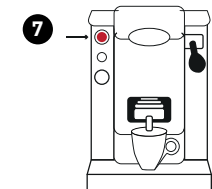
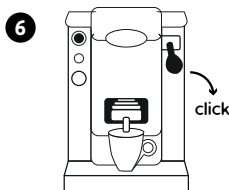
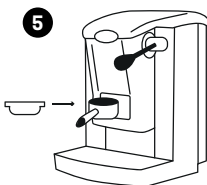
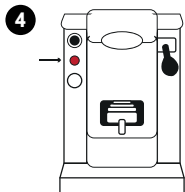
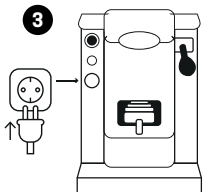

## GEBRAUCHSANWEISUNGEN FÜR DIE VERWENDUNG DER DAMPFDÜSE

1. Den Schalter A auf ON-Licht einlegen
2. Warten, bis wann die Temperaturanzeigelampe B zu ist
3. Das Kännchen stellen, die Dampfdüse einstecken und den Versorgungsschalter C betätigen
4. Wenn das gewünschte Dampfversorgungsniveau erreicht wird, den Versorgungsschalter C zu machen.



(A) Zündanlassschalter Dampfgruppe ON/OFF (B) Temperaturanzeigelampe (C) Dampfversorgungsschalter (D) Dampfdüse (E) Plastikgriff

## ✓ CONSEJOS ÚTILES DE MANTENIMIENTO



Die Instandhaltungs- und Reinigungsbedienungen müssen immer durchgeführt werden, wenn die Maschine kalt und mit keinem Stromnetz verbunden ist.



Für die Maschinenreinigung benutzen Sie bitte einen einfachen feuchten Lappen, tauchen Sie bitte nie die Maschine ins Wasser und stecken Sie bitte nicht ihre Teile in die Spülmaschine ein.



Benutzen Sie bitte keine Lösungsmittel oder aggressiven chemischen Stoffe.



Trocknen Sie bitte nie die Maschine oder ihre Teile im Ofen jeder Art.

» Weitere nützliche Ratschläge finden Sie bitte unter: [www.faberitaliasrl.it](http://www.faberitaliasrl.it)

هنيئاً لك اقتناء ماكينة قهوة إكسبريس **فاير** و شكراً لاختيارك لنا.

إن دليل المستخدم هذا سيساعدك في تشغيل الماكينة بشكل صحيح و الصيانة الدقيقة لها.  
إن دليل المستخدم هذا يعد جزءاً من مكونات الجهاز و يجب أن يتم اعطائه للمستخدم الجديد في حال بيع الماكينة.

هذا الجهاز يستخدم في الأماكن المنزلية و البيئات المشابهة مثل:  
مطابخ و استراحات المكاتب و المحلات و أماكن العمل.  
بيوت المزارع و أماكن السكن الجماعي.  
من قبل نزلاء الفنادق و الموتيلات و الأماكن السكنية المشابهة.  
في المساكن التي تقدم خدمة سرير و فطور.

## الضمان

هذا الجهاز مضمون ضد العيوب المصنعية لمدة 24 شهراً من تاريخ الشراء.  
إن الأضرار الناتجة عن الاهتراء نتيجة الاستخدام أو سوء الاستخدام أو ارتفاع جهد الكهرباء أو الماس الكهربائي أو أية أضرار نتيجة الترسبات الكلسية سوف لن تكون مغطاة بهذا الضمان.

هذا الضمان يمنح من قبل المصنع للعميل.  
إن شركة فاير إيطاليا شركة ذات مسؤولية محدودة سوف لن تكون مسؤولة عن أية أضرار تجارية افتراضية أو أية أضرار لسمعة أي شركة أو أضرار على الأشخاص أو الأشياء ناتجة عن الاستخدام الخاطئ للجهاز.

## إعلان المطابقة لعلامة CE

إن هذا الجهاز مطابق للمواصفة الأوروبية رقم UE/2014/30 (مواصفة التوافق الكهرومغناطيسي) و المواصفة رقم UE/2014/35 (مواصفة الجهد المنخفض)



قبل أن تتركب ماكينة القهوة يجب أن تنتبه إلى العلامات أدناه التي ستساعدك على تجنب المواقف الخطيرة و المواقف التي تحتاج إلى أخذ الحيطة و الحذر لكي لا تخرب الجهاز بالإضافة إلى بعض التعليمات التي ستساعدك على الاستفادة بشكل أفضل من الجهاز.



انتباه/تحذير



خطر



نصائح مفيدة

- ❗ لا تشغل الجهاز في الخارج
- ❗ لا تلمس الجهاز بأيدي مبلولة أو حافي القدمين.
- ❗ لا تعرض الجهاز للعوامل الجوية حتى لو كان مفصلاً عن التيار الكهربائي.
- ❗ لا تدخل يديك و أي جسم معدني أو أي شيء آخر داخل الماكينة حتى لو كانت مفصولة عن التيار.
- ❗ هذا الجهاز غير معد للاستخدام من قبل الأشخاص (متضمناً الأطفال) الذين لديهم نقص في القدرة الحركية، الحسية أو العقلية أو الأشخاص الذين لديهم نقص في الخبرة أو المعرفة بتشغيل الأجهزة إلا إذا تم تدريبهم و الإشراف عليهم لتشغيلها من قبل شخص مسؤول عن سلامتهم.
- يجب الإشراف على الأطفال لكي لا يقوموا باللعب بالجهاز.
- ❗ يجب فصل الجهاز عن مصدر الطاقة قبل أي محاولة إصلاح.
- 👏 يرجى تفقد سلك الطاقة بشكل دوري و الذي يمكن استبداله فقط من قبل فني المصنع.
- 👏 لخدمات الصيانة نرجو الاتصال على مركز الصيانة الخاص بِنّا.
- ✅ في حال تلف سلك التيار، يجب استبداله من قبل الشركة المصنعة، وكيال الخدمة أو شخص مؤهل على نحو مماثل لتجنب الخطر.

## سلوت بلاست

ماكينة قهوة اكسبريس أنيقة و صغيرة الحجم لأقراص القهوة بحجم مدروس و متوازن لاستخدام المنزل أو المكتب

### المواصفات الفنية

مبادل حراري مصنوع من الألمنيوم مع نظام توزيع للمياه مصنوع من النحاس.

ضاغط الأقراص مصنوع من النحاس.

منظم درجة الحرارة من 95 ° / 98 °

سعة خزان الماء 1.4 لتر

الكهرباء: 220 فولت تردد 60 هرتز

أبعاد الجهاز:

عرض: 21سم

عمق: 32سم

ارتفاع: 35سم

الوزن: 5كغ

### التركيب لأول مرة:

قم بإزالة التغليف و تأكد بأن الجهاز سليم و اذا وجد أي عيب أو كسر يجب الاتصال بالبائع فوراً.  
إن جميع مواد التغليف تشكل خطراً على الأطفال و الأناس ذوو الاحتياجات الخاصة.  
يجب أن يتم توصيل الجهاز إلى مقبس كهربائي مؤرض حيث أن المصنع غير مسؤول عن الجهاز في حال لم يتم توصيله حسب توصيات المصنع.

يجب التأكد من أن المواصفات الفنية للجهاز مطابقة للنظام الكهربائي لديك.  
لا تستخدم توصيلات كهربائية أو مقابس غير مطابقة للمواصفات القياسية.



ة،  
 (١) زر التشغيل و الإطفاء، (٢) ضوء الحرارة،  
 (٣) زر اخراج القهوة، (٤) مسكة فتح اغلاق حجرة أقراص القهو  
 (٥) حجرة أقراص القهوة، (٦) خزان الماء، (٧) غطاء خزان الماء،  
 (٨) فوهة اخراج القهوة

زر مؤشر الحرارة (B) زر تشغيل/إيقاف مجموعة المبخر (A)  
 حمالة بلاستيكية للمبخر (E) المبخر (D) زر بدء التبخير (C)

#### دليل استخدام المبخر

1. إلى وضعية بدء التشغيل و سوف يضيء الزر (A) اضغط الزر
2. (B) انتظر حتى ينطفئ الزر
3. (C) و اضغط زر التشغيل (D) ضع الفنجان تحت المبخر.
4. (C) عند الانتهاء أطفئ زر التبخير

## تعليمات الاستخدام

- ١- ارفع غطاء خزان الماء و أخرج خزان الماء.
- ٢- املئ الخزان بمياه عادية و ليست مياه غازية.
- ٣- أعد الخزان إلى مكانه و تأكد بأن أنبوب السيليكون داخل الخزان.
- ٤- قم بتوصيل التيار الكهربائي.
- ٥- قم بضغط زر تشغيل الماكينة (١) حيث سيضيئ الزر.
- ٦- انتظر حتى ينطفئ ضوء مؤشر الحرارة (٢).
- ٧- ضع قرص القهوة في الحجرة الخاصة به (٥) و اسحب المسكة للأسفل حتى تسمع صوت طقة.
- ٨- ضع الفنجان تحت فوهة خروج القهوة (٨) و اضغط زر ضخ القهوة (٣).
- ٩- عندما يمتلئ الفنجان بالمستوى المطلوب من القهوة قم بإيقاف ضخ القهوة بضغط الزر (٣) مرة أخرى.
- ١٠- ارفع المسكة للأعلى و قم بإخراج القرص المستخدم.

## معلومات مفيدة للصيانة و التنظيف:

- إن أي عملية تنظيف أو صيانة للجهاز يجب أن تتم فقط بعد أن يبرد الجهاز و يتم فصله عن مصدر الكهرباء.
- استخدم قطعة قماش رطبة لتنظيف الجهاز و يجب التأكد من عدم دخول الماء إلى داخل الجهاز.
- لا تغسل الجهاز في غسالة الصحون.
- لا تستخدم منظفات قوية لتنظيف الجهاز. لا تجفف الجهاز أو مكوناته في الفرن.



Ref. Certif. No.

DE 3 - 17462

IEC SYSTEM FOR MUTUAL RECOGNITION OF TEST  
CERTIFICATES FOR ELECTRICAL EQUIPMENT (IECEE)  
CB SCHEMESYSTEME CEI D'ACCEPTATION MUTUELLE DE  
CERTIFICATS D'ESSAIS DES EQUIPEMENTS  
ELECTRIQUES (IECEE) METHODE OC**CB TEST CERTIFICATE  
CERTIFICAT D'ESSAI OC**Product  
Produit

Electric coffee makers

Name and address of the applicant  
Nom et adresse du demandeurFABER ITALIA S r.l.  
Via Pozzillo snc. Loc. Ponteseice  
81100 Caserta (CE), ITALYName and address of the manufacturer  
Nom et adresse du fabricantFABER ITALIA S r.l.  
Via Pozzillo snc. Loc. Ponteseice, 81100 Caserta (CE), ITALYName and address of the factory  
Nom et adresse de l'usineFABER ITALIA S r.l.  
Via Pozzillo snc. Loc. Ponteseice, 81100 Caserta (CE), ITALYRatings and principal characteristics  
Valeurs nominales et caractéristiques principalesRated voltage: 230 V- 1N  
Rated frequency: 50 Hz  
Rated power: 500 W  
Degree of protection: IPX0  
Protection class: ITrade mark (if any)  
Marque de fabrique (si elle existe)

FABER

Model/type Ref.  
Ref. de type

SLOT PLAST, SLOT INOX

Additional information (if necessary)  
Information complémentaire (si nécessaire)A sample of the product was tested and found  
to be in conformity with  
Un échantillon de ce produit a été essayé et a été  
considéré conforme à laIEC 60335-1(ed 5)  
IEC 60335-2-15(ed 5),am1,am2as shown in the Test Report Ref. No.  
which forms part of this certificate  
comme indiqué dans le Rapport d'essais numéro  
de référence qui constitue une partie de ce  
certificat

068-15069-000

This CB Test Certificate is issued by the National Certification Body  
Ce Certificat d'essai OC est établi par l'Organisme National de CertificationDate: 2016-02-17  
CB 16 02 04931 001  
Domenico Pignataro

TUV SÜD Product Service GmbH - Certification Body - Riederstrasse 65 - D-80339 München

Product Service



Product Service

## Attestation of Conformity

No. NBA 16 04 94931 003

**Holder of Certificate:** FABER ITALIA S.r.l.Via Pozzillo snc  
Loc. Pomeselice  
81100 Caserta (CE)  
ITALY**Product:** Electric coffee makers

This Attestation of Conformity is issued on a voluntary basis according to the Low Voltage Directive 2014/35/EU relating to electrical equipment designed for use within certain voltage limits. It confirms that the listed equipment complies with the principal protection requirements of the directive and is based on the technical specifications applicable at the time of issuance. It refers only to the particular sample submitted for testing and certification. See also notes overleaf.

Test report no.: SIC15059.01

Date, 2016-04-18

(Domenico Pignataro)



**CE** After preparation of the necessary technical documentation as well as the EU conformity declaration the required CE marking can be affixed on the product. That declaration of conformity is issued under the sole responsibility of the manufacturer. Other relevant EU-directives have to be observed.

Page 1 of 2



Product Service

**Attestation of Conformity**  
**No. NBA 16 04 94931 003**

**Model(s):** SLOT PLAST, SLOT INOX

**Brand:** Faber

<b>Parameters:</b>	Rated voltage:	230 V~ 1N
	Rated frequency:	50 Hz
	Rated power:	500 W
	Protection class:	I
	Degree of protection against liquids:	Ordinary

<b>Tested according to:</b>	EN 60335-1:2012/A11:2014
	EN 60335-2-15:2002/A11:2012
	EN 62233:2009



Product Service

Page 2 of 2



**OFl srl**

Viale Melvin Jones 8, 81100 Caserta

info@officinadifaber.com

[www.faberitaliasrl.it](http://www.faberitaliasrl.it)

